

Features

- Selectable over or under voltage function
- Wide voltage monitoring range: 1-255 V AC in 1V steps
- 3rd harmonic filtering for neutral displacement applications
- Wide range auxiliary supply 40-275 V AC & 40-300 V DC
- 20-70V DC aux. Optional
- Auxiliary supply fail alarm
- Instantaneous p/u LED
- Undervoltage VT alarm function
- Non-volatile trip indication
- 5 C/O output contacts
- 2 contacts may be configured for instantaneous operation
- Two time delay ranges:
 - 0-2.55 s in 10 ms steps
 - 0-25.5 s in 100 ms steps
- Relay enable status input
- Push button & status input to reset trip LED
- Size 2M draw out case

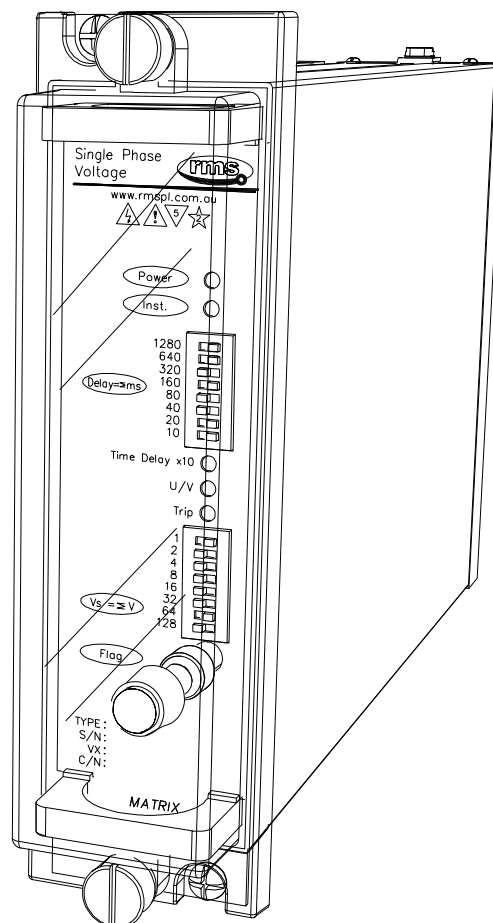

2V76 depicted in a 2M28 case

Description

The 2V76 series relay is a single phase protection class AC voltage relay. It may be configured for under or over voltage operation & includes a filter for rejection of third harmonics for neutral displacement applications.

A definite time delay element is included which is initiated by the voltage detection circuit & drives the time delayed output contacts.

Voltage & time settings are fully adjustable using DIL switches readily accessible on the front panel of the relay & provide a high level of repeatability & accuracy. Visual indication of an output relay operation is provided by a non volatile LED indicator which may be hand or remotely reset.

A configurable status input is provided to ENABLE the operation of the 2V76 on application or removal of a control voltage.

Application

Made in Australia

The 2V76 series relay can be configured to suit a range of AC voltage protection applications. For example:

UNDER VOLTAGE

High speed detection of undervoltage in automatic transfer equipment,
 Protection of induction motors against the restoration of supply following the loss or severe reduction in that supply.
 Application in under frequency load shedding schemes

OVER VOLTAGE

Protection of synchronous motors & motors driving high inertia loads.
 Protection of hydro generators against over speed.

NEUTRAL DISPLACEMENT

The 2V76 may be applied as a neutral displacement relay. In this application the 2V76 may be applied for earth fault protection of alternator stator windings where the neutral is earthed through a voltage transformer or distribution transformer. The relay is designed for this application such that its response to third harmonics is suppressed, thus making it inoperative to the third harmonic load imbalance which normally flows in the generator neutral. The application of the relay also includes protection against unbalance conditions in capacitor banks & the detection of earth faults in impedance earthed, solidly earthed or un-earthed systems.

A switchmode power supply provides a very wide auxiliary operating range. A relay fail alarm is provided in the form of a C/O contact which is picked up when the auxiliary supply is healthy.

AC VOLTAGE INPUT

Nominal input: 110 V AC
 Maximum withstand: 300 V AC continuous
 AC Burden: <1 VA over voltage setting range
 Rated frequency: 50 Hz or 60 Hz
 Frequency range: Rated frequency +/-2 Hz
 Measurement accuracy: +/-1% of setting or +/-0.5 V over the rated frequency range

AC VOLTAGE SETTING RANGE Vset

1-255V AC in 1V steps

Vset = ΣV switches set to ON (LHS) on the front panel.

VOLTAGE SENSING FUNCTION

The voltage sensing element is only active when the initiate input is enabled.

Overvoltage mode: Set configuration switch 5 to **ON**

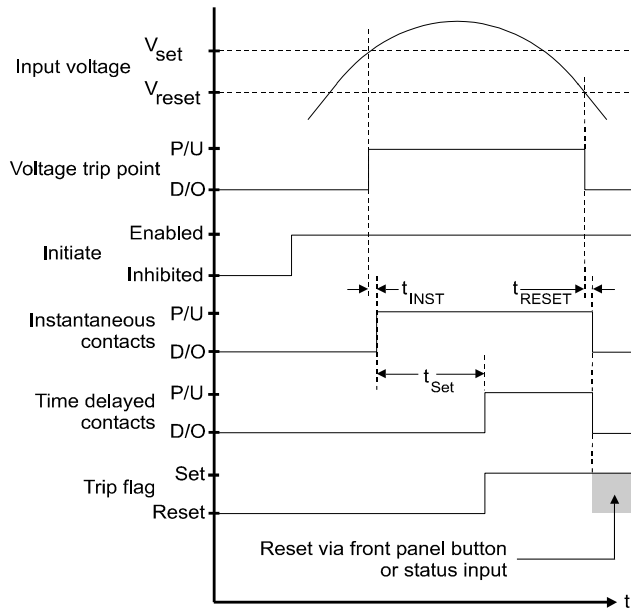

Figure 1:

Undervoltage mode: Set configuration switch 5 to **OFF**

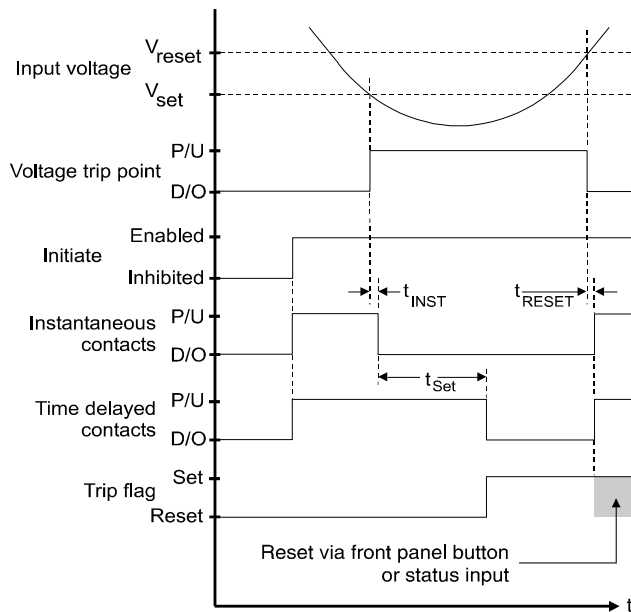

Figure 2:

HARMONIC REJECTION

Harmonic filter rejection: >20x setting at >100 Hz

DROPOUT PICKUP RATIO OF VOLTAGE ELEMENT

HIGH 90% setting: PCB jumper J118 fitted left – Factory default
 LOW 80% setting: PCB jumper J118 fitted right as per figure 3.

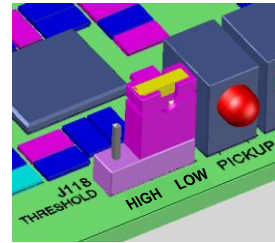

Figure 3:

To change the dropout / pickup ratio remove the relay module from the case, locate the three pin jumper header position J118 & fit jumper for HIGH or LOW dropout pickup ratio.

UNDERVOLTAGE ALARM FUNCTION

The 2V76 provides a dedicated undervoltage alarm function for application as a VT fail alarm & is active when the initiate input is enabled.

The undervoltage alarm set point U/Vset, is a fixed percentage of Vset. When the input voltage falls below this level, C/O contact 1 & the front panel LED will operate after a short time delay to avoid spurious operation due to transients.

The U/V alarm LED & output contact are self reset when the voltage level is restored above U/Vreset.

Set point: U/Vset 0.2 x Vset
 Reset point: U/Vreset 0.3 x Vset
 Voltage measurement accuracy: +/-3V
 Fixed time delay setting: ~500 ms

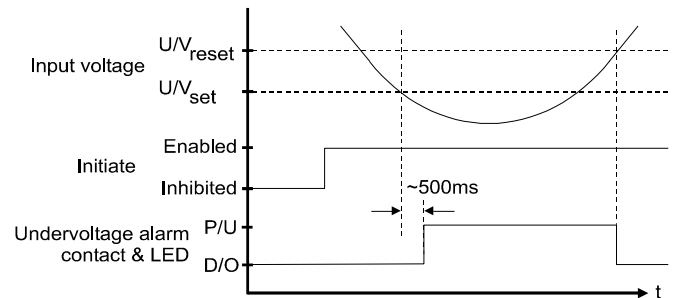

Figure 4:

When the AC sensing voltage input is ramped up from below the undervoltage alarm set point as depicted in figure 5, a short time delay (TuvM), is applied to mask spurious pick up of the voltage element. This time delay will result in an additional time delay to the instantaneous contacts when the 2V76 is configured to operate in overvoltage mode as described in the following sections.

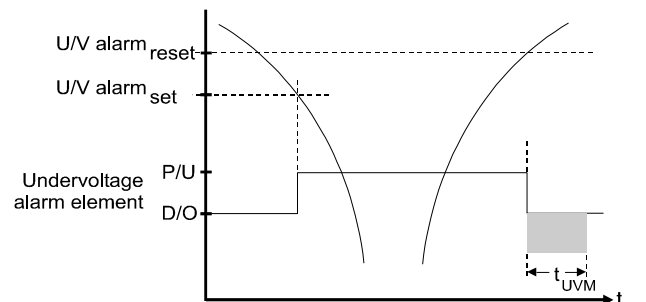

Figure 5:

OPERATE TIMING – INSTANTANEOUS

The overall operate time of the instantaneous output contacts, $t_{INSTANTANEOUS}$, varies as a function of the scale of the input voltage change and the position on the waveform of the input change.

$$t_{OP} = 50ms^{***}$$

* Times specified are for AC input voltage steps applied synchronous with the zero point crossing of V_{IN}

** Worst case for voltage step applied on falling point on wave add 5ms

Overvoltage mode:

When the input voltage rises from below the undervoltage alarm set point level, an undervoltage mask time delay is imposed:

$$t_{UVM} = 30ms$$

Overall Pick Up operate times are extended for this period where the input voltage is initiated from less than the Undervoltage Set Point.

Where the input voltage is initiated from above the Undervoltage Set point there is no delay:

$$t_{UVM} = 0ms$$

Where the 2V76 is configured to operate in overvoltage mode the instantaneous operate time is defined in Figure 6:

$$t_{INSTANTANEOUS} = t_{UVM} + t_{OP}$$

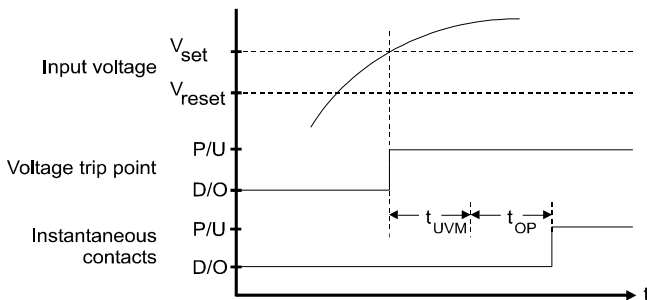

Figure 6:

In this mode the voltage element will always be reset from above the Undervoltage Set point such that $t_{RESET} = t_{OP}$

Undervoltage mode:

Where the 2V76 is configured to operate in undervoltage mode the instantaneous operate time is defined in Figure 7:

As the input voltage is starting from above the Undervoltage set point $t_{UVM} = 0ms$.

$$t_{INSTANTANEOUS} = t_{OP}$$

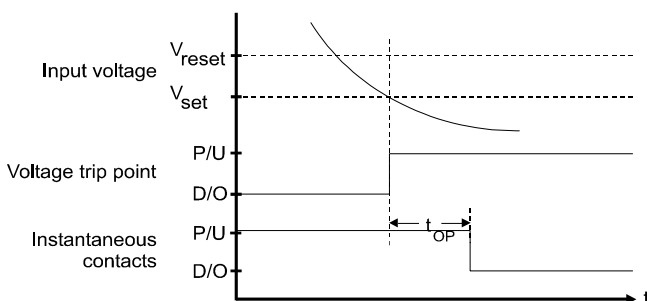

Figure 7:

If the voltage element is reset from a voltage which starts from above the Undervoltage Set point then $t_{RESET} = t_{OP}$

If the voltage element is reset from a voltage which starts from below the Undervoltage Set point then $t_{RESET} = t_{OP} + 30ms$

INSTANTANEOUS OUTPUT CONTACTS

When output contacts 4 & 5 are configured for Instantaneous operation they will pick up when the relay is enabled and V_s is above / below the voltage pick up set point.

Refer to timing shown in Figures 6 & 7.

Set configuration switch 3 to **ON** to select Instantaneous operation for output contacts 4 & 5.

TIME DELAYED OUTPUT CONTACTS

Output contact 1 has a fixed time delay for U/V alarm. The contact will automatically and independently reset after ~500ms

Output contacts 2 & 3 **always** operate in time delayed mode.

Output contact 4 & 5 will also operate in time delayed mode provided configuration switch 3 is set to **OFF**.

Time Delay Setting Ranges

$t_{set} = \sum$ ms switches set to ON (LHS) on front panel.

0 to 2.5 sec in 10 ms steps; or

0 to 25 sec in 100ms steps (when x10 time range selected)

Where all switches are set to OFF (RHS), the time delay set point is instantaneous.

The 10x setting multiplier is activated when configuration switch 4 is set to **OFF** to extend the timer range to 25 sec.

Time Delay Setting Changes

The time delay & function settings should only be changed when the timing initiate LED is extinguished. Time delay settings are read at the beginning of each timing sequence.

Time Delay - Accuracy

Nominal $t_{set} \pm 0.5\%$

Note: The accuracy of the delay timer does not include output contact operate or reset times.

TIMER RESET

If the input voltage is restored to above / below the voltage trip level before the preset time delay t_{set} has expired, the time delay trip output contacts will not operate provided the timer has adequate time to reset.

If the voltage element drops out before the pre set time delay is reached the timing element will reset in <60 ms at 2x V_s .

CONFIGURATION SWITCHES

Configuration switches are accessible to the user & can be set by withdrawing the relay module & following the instructions on the side plate label. A bank of 5 switches are provided as depicted below & are read each time the 2V76 is powered up:

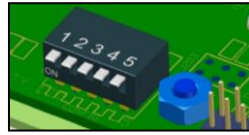
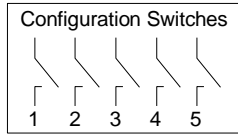

While the function of the configuration switches may vary for special custom models, the standard functions & default settings are described in the Ordering Information section.

FRONT PANEL INDICATORS

Five LED indicators are provided on the front panel:

Power	On solid when auxiliary supply healthy	Green
U/V Alarm	On solid when input below threshold	Red
Timing	Flashing during timing	Amber
Trip	On solid when output relay operated	Red
Range x10	On when the x10 time range selected	Green

The U/V alarm & trip LED's status is stored in non volatile memory & will be restored when the 2V76 is powered up after loss of the auxiliary supply. The preserved trip LED state is reset using the front panel trip LED reset button or status input.

STATUS INPUT OPERATING VOLTAGE (AC rejection filter)

The operating range of the status inputs are set using internal configuration switch 1. This setting may be pre defined when ordering.

18 - 300V DC Set Configuration Switch to **ON**
In this mode the universal status input will reject AC signals that may be induced on the control wiring. Suitable for high security applications where a DC battery supply is available.

18 - 300V DC & 18 - 275V AC Set Configuration Switch to **OFF**
In this mode the universal status input is designed to operate on both AC & DC input voltages. Suitable for applications where an AC auxiliary voltage is available such as transformer or generator control panels.

STATUS INPUT MINIMUM OPERATING CURRENT

10 mA P/U for 1 ms then reducing to 1.5 mA after 4 ms.

While the function of the configuration switches may vary for special custom models, the standard functions & default settings are described in the Ordering Information section.

STATUS INPUT OPERATING TIME

Initiate input	Minimum	AC Rejection Filter	
		ON	OFF
DC	P/U	<16 ms	<4 ms
	D/O	<4 ms	<16 ms
AC	P/U	N/A	<23 ms
	D/O	N/A	<33 ms

Table 1

RELAY ENABLE INPUT

Apply volts to enable: Set configuration switch 2 **ON**
Remove volts to enable: Set configuration switch 2 **OFF**

REMOTE RESET INPUT

Application of a control voltage to remote flag reset input will cause the trip LED to be reset.

AUXILIARY SUPPLY

40-275 V AC / 40-300 V DC or 20-70 V DC switchmode supply.

BURDEN

Less than 2 watts during idle & timing.
Less than 4 watts when output relays are energized.

RELAY FAIL ALARM

A C/O alarm contact is maintained in the energized state when all of the following conditions are met:

- The auxiliary supply is applied
- The internal 24 V DC rail is within acceptable limits
- The CPU hardware watchdog maintains a pulsing output

A CPU software watchdog records "suspect" events to an assert register & if necessary performs a soft restart.

OUTPUT RELAY CONTACT CONFIGURATION

1 C/O undervoltage alarm contact
4 C/O time delayed contacts or
2 C/O time delayed + 2 C/O instantaneous contacts

OUTPUT CONTACT DWELL TIME

Once operated all time delayed output contacts have a minimum dwell time of 100ms.

OUTPUT CONTACT RATINGS

IEC60255-0-2

Carry continuously	5A AC or DC
Make & carry	0.5 s 20 A AC or DC
L/R ≤ 40ms & V ≤ 300V	0.2 s 30 A AC or DC
	AC resistive 1,250 VA
Break capacity	AC inductive 250 VA @ PF ≤ 0.4
I ≤ 5A & V ≤ 300V	DC resistive 75 W
	DC inductive 30 W @ L/R ≤ 40 ms
	50 W @ L/R ≤ 10 ms
	10 ⁶ at maximum load
Minimum number of operations	0.5W limit 10mA / 5 V
Minimum recommended load	

TRANSIENT OVERVOLTAGE

IEC60255-5 CLASS III

Between all terminals & earth 5 kV 1.2/50 us 0.5 J
Between independent circuits without damage or flashover 5 kV 1.2/50 us 0.5 J

INSULATION COORDINATION

IEC60255-5 CLASS III

Between all terminals & earth 2.0 kV rms for 1 min.
Between independent circuits 2.0 kV rms for 1 min.
Across normally open contacts 1.0 kV rms for 1 min.

AUXILIARY SUPPLY

IEC60255-11

Allowable breaks / dips in supply ≤ 20 ms
Collapse to zero from nominal voltage

HIGH FREQUENCY DISTURBANCE

IEC60255-22-1 CLASS III

2.5 kV 1MHz common mode ≤ 3% variation
1.0 kV 1MHz differential mode

ELECTROSTATIC DISCHARGE

IEC60255-22-2 CLASS III

6 kV contact discharge ≤ 5% variation

FAST TRANSIENT

IEC60255-22-4

4 kV, 5/50 ns, 100 KHz repetitive ≤ 5% variation

TEMPERATURE RANGE

IEC68-2-1/2

Operating: -5 to +55°C
Storage: -25 to +75°C

HUMIDITY

IEC68-2-78

40 °C & 95% RH non condensing

CASE

Size 2M28-S draw out
28 M4 screw terminals
Flush panel mount or 4U high 1/8 width 19 inch rack mount

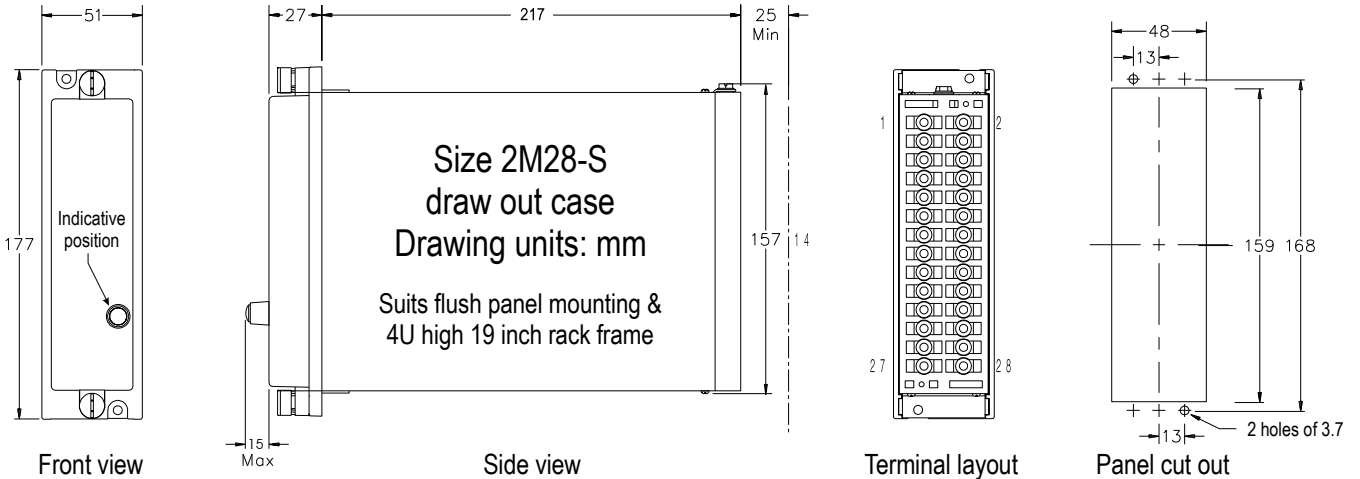
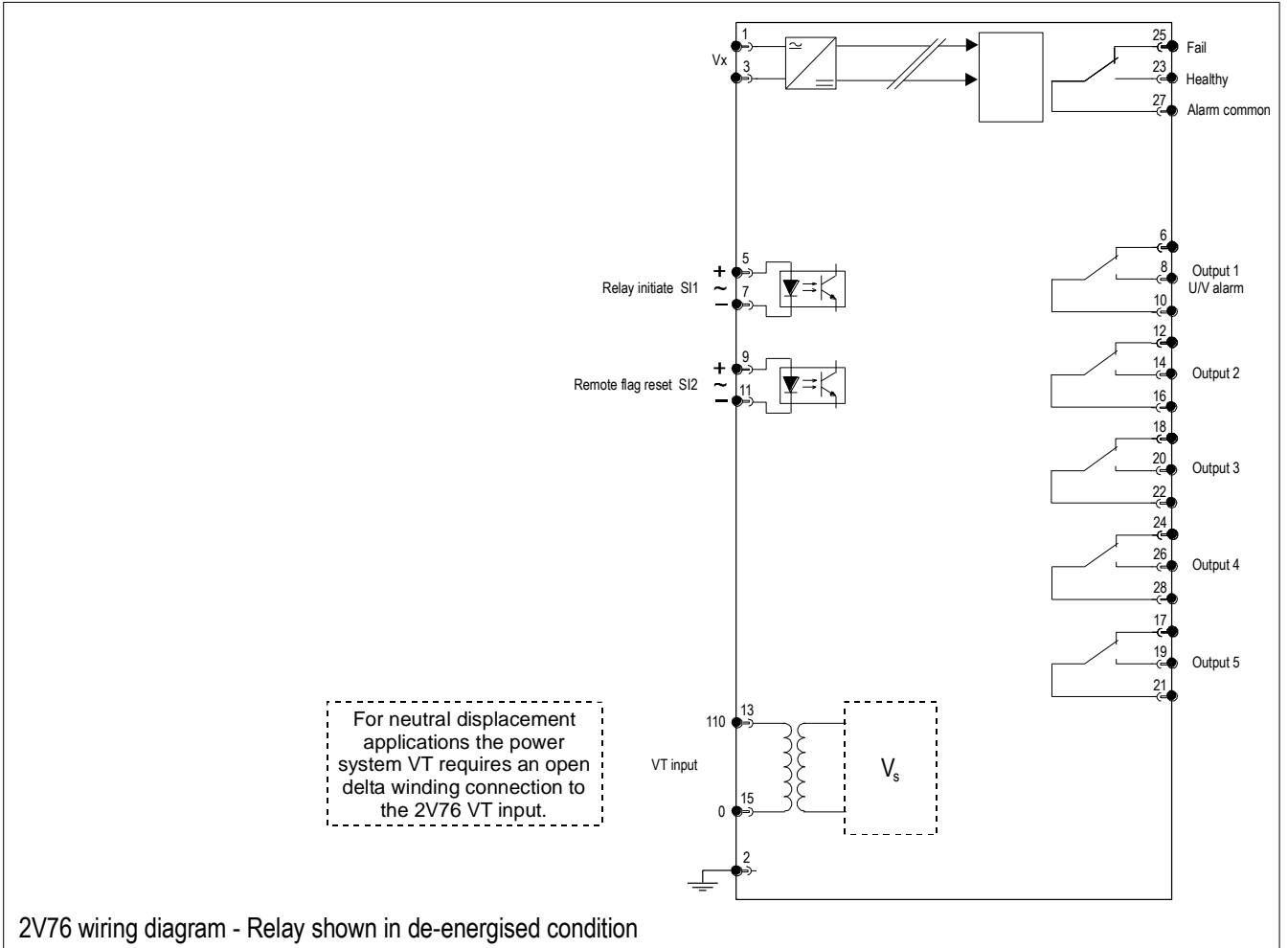

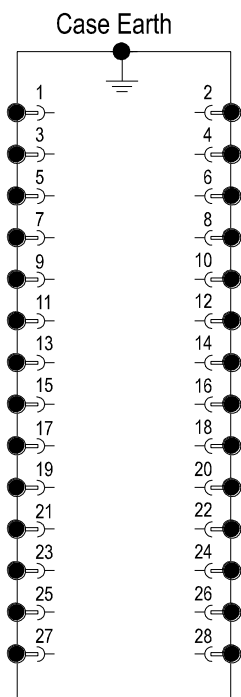

2M28 Case terminations (REAR VIEW)

Ordering Information

ORDER CODE

The order code determines the production build in the factory & cannot be changed in the field.

Generate the required order code as follows: e.g. 2V76-BA

General Type	Order Code	
2V76	1	2

1 AUXILIARY SUPPLY RANGE

- A 20-70 V DC
- B 40-275 V AC & 40-300 V DC

2 SYSTEM FREQUENCY

- A 50 Hz
- B 60 Hz

CONFIGURATION CODE (Optional specification)

The configuration code can be set in the field by withdrawing the relay module & following the instructions on the side plate label.

The configuration code may be specified at time of order so that the relay will be shipped from the factory pre-set to meet customer requirements. e.g. CONFIG-01011

If a configuration code is not specified the factory default will be set as indicated below. i.e. CONFIG-11111

Specify factory Configuration	Configuration Switches				
CONFIG	1	2	3	4	5

1 STATUS INPUT OPERATION

- 1 ON DC operation only - AC rejection ON (Default)
- 0 OFF AC / DC operation - AC rejection OFF

2 RELAY ENABLE INPUT

- 1 ON Apply volts to enable (Default)
- 0 OFF Remove volts to enable

3 OUTPUT RELAY FUNCTION

- 1 ON Output contacts 4 & 5 will operate instantaneously when V_s is beyond the voltage pick up threshold irrespective of the front panel time delay settings while output contacts 2 & 3 are time delayed (Default)
- 0 OFF Outputs contact 2 to 5 are time delayed

4 TIME RANGE MULTIPLIER

- 1 ON Selected time range x1 (Default)
- 0 OFF Selected time range x10

5 RELAY MODE

- 1 ON Overvoltage mode (Default)
- 0 OFF Undervoltage mode



www.rmspl.com.au



Relay Monitoring Systems Pty Ltd design, manufacture and market a wide range of electrical protection and control products for application on high voltage power systems. The company's depth of manufacturing and engineering expertise is backed up by many years of experience since the formation of its predecessor, Relays Pty Ltd (RPL), in 1955. This experience combined with a broad base of field proven product types enables RMS to service specific customer needs by producing relays on demand and with typically short lead times.

Relay Monitoring Systems Pty Ltd

6 Anzed Court
Mulgrave, Victoria 3170
AUSTRALIA
Ph: +61 3 8544 1200
Fax +61 3 8544 1201
Sales: rms@rmspl.com.au
www.rmspl.com.au
www.relays.com.au

ISO9001 Quality Accreditation

RMS holds NCSI (NCS International Pty Limited) registration number 6869 for the certification of a quality system to AS/NZS ISO9001:2008.

Due to RMS continuous product improvement policy the information contained in this document is subject to change without prior notice.

© 2014 Relay Monitoring Systems Pty Ltd ABN 76 052 484 483